



ottomotores

CUMMINS SERIE 4B

Energía que Mueve al Mundo

Definiciones

Potencia Prime

Estos valores son aplicables para el suministro de energía eléctrica continua (a carga variable) en lugar de la red comercial + 10% sobrecarga

Potencia Stand by

Estos valores son aplicables para el suministro de energía eléctrica continua (con carga variable) en caso de falla de la red comercial. No se permite sobrecarga sobre estos valores.

Tabla de Potencias

Modelo	Voltaje	kVA Prime	kWe Prime	kVA Stand-by	kWe Stand-by
CNY50	220-440V	57	45	63	50
CNY60	220-440V	69	55	75	60
CNY80	220-440V	91	73	100	80

0.8 Factor de potencia



Información Técnica

Datos Técnicos	CNY50	CNY60	CNY80
Frecuencia:	60 Hz	60 Hz	60 Hz
Marca / Modelo	4BT3.3G3	4BT3.9G4	4BTA3.9G3
Generador Modelo:	Stamford UCI224D	Stamford UCI224E	Stamford UCI224G
Número de Cilindros:	4 en línea	4 en línea	4 en línea
Diametro por Carrera :in (mm)	3.74X4.53 (95X115)	4.02X4.72 (102X120)	4.02X4.72 (102X120)
Relación de Compresión:	18.0:1	16.5:1	16.5:1
Aspiración:	Turbocargado	Turbocargado	Turbo y Postenfriado
Velocidad:	1800 RPM	1800 RPM	1800 RPM
Potencia: BHP(kWm)	80 (60)	102 (76)	125 (93)
Presion Efectiva: psi (kPA)	177 (1220)	190 (1312)	233 (1604)
Velocidad de Piston: ft/min (m/s)	1359 (6.9)	1416 (7.2)	1416 (7.2)
Consumo a plena carga: lt / hr - 100%	15	19	24
Calor Expulsado en el Sistema de Escape: BTU/min (kWm)	2858 (50.3)	3390 (59.5)	4500 (79.2)
Calor Expulsado en el Sistema de Enfriamiento: BTU/min (kWm)	2181 (38.3)	2240 (39.3)	2860 (50.3)
Temperatura de Escape: °F (°C)	1090 (588)	919 (493)	815 (435)
Flujo de Enfriamiento en el Radiador m³/seg - FPM	llame a fabrica	llame a fabrica	llame a fabrica
Flujo de Escape: cfm (litros/s)	420 (198)	516 (244)	366 (173)

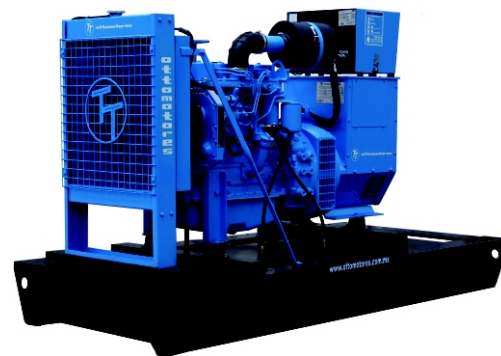

Nota: Imagen de carácter ilustrativa ya que los equipos en foto pudieran incluir accesorios opcionales

Como leer nuestro codigo: Ejem: CNY50

C=Motor Cummins
N=Generador Newage Stamford
Y=60Hz-1800 RPM
50= Potencia del Equipo.



LAPEM

Ottomotores, S.A de C.V.

Calz. San Lorenzo No.1150
Col. Cerro de la estrella, C.P. 09860
Delg. Iztapalapa México, D.F.
Tels:52-55-5624-5600

Fax: 52-55-5426-5521 / 52-55-5426-5581
email: ventas@ottomotores.com.mx

sitio web: www.ottomotores.com.mx

Dimensiones

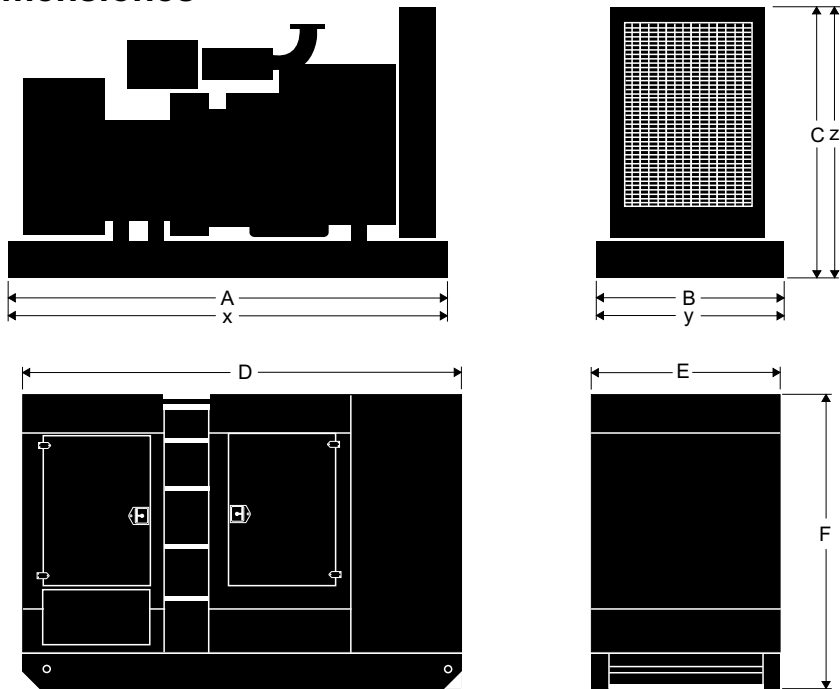

CNY50	Equipo con Base Estructural			Equipo con Base Tanque			Equipo con Caseta Acústica*		
	A	B	C	x	y	z	D	E	F
	175,00	70,00	108,50	218,00	109,00	134,50	260,00	109,00	165,00
	Peso: 624,00 kgs			Peso: 945,00 kgs			Peso: 1392,00kgs		

CNY60	Equipo con Base Estructural			Equipo con Base Tanque			Equipo con Caseta Acústica*		
	A	B	C	x	y	z	D	E	F
	175,00	70,00	108,50	218,00	109,00	134,50	260,00	109,00	165,00
	Peso: 650,00 kgs			Peso: 1069,00 kgs			Peso: 1489,00kgs		

CNY80	Equipo con Base Estructural			Equipo con Base Tanque			Equipo con Caseta Acústica*		
	A	B	C	x	y	z	D	E	F
	202,00	77,00	123,00	218,00	109,00	137,50	260,00	109,00	165,00
	Peso: 841,00 kgs			Peso: 1129,00 kgs			Peso: 1575,00kgs		

[*] Equipo opcional

Información Técnica

Nota: las condiciones de referencia estándar son de 25 °C (77 ° F) temperatura de entrada de aire. Todos los datos de desempeño de motores son basados en la potencia mencionada arriba.

Datos de consumo de combustible a plena carga con combustible diesel tienen una gravedad específica de 0,85.

Comercializado por:

Módulos de Control



Ottomotores tiene una posición única en la fabricación de grupos electrógenos utilizando en ellos módulos de control que cumplen con todos los niveles de requerimiento del mercado nacional y de exportación.



Las diferentes soluciones de controles que se tienen para nuestra gama de plantas generadoras, permite una operación simple en modo manual y automático, así mismo permiten desarrollar proyectos de sincronía entre plantas generadoras o con la red de energía eléctrica.



La familia de módulos de control en transición abierta (DALE 3200) permite tener control en forma automática de la unidad de transferencia, así como el monitoreo del grupo generador.



Nuestro módulos de control cuentan con puerto de comunicación RS485 para la comunicación remota con el grupo generador.



Los módulos pueden ser monitoreados a través de un excelente software para observar parámetros del equipo de manera fácil y rápida.



La familia de módulos de control para la sincronía (6100, 6050 y 6300), incorporan un amplio sistema de monitoreos además de conexión a Internet (LAN) o mensaje SMS vía celular, o usando los puertos de comunicación RS485 a través de ModBus



ottomotores

Energía que Mueve al Mundo

Calz. San Lorenzo No.1150
Col. Cerro de la Estrella, C.P.09860
Delegación Iztapalapa México D.F.
Tels: 52-55-5624-5600
Fax: 52-55-5426-55-21 / 52-55-54265581

E-mail ventas1@ottomotores.com.mx
ventas2@ottomotores.com.mx

Web site. www.ottomotores.com.mx

© Ottomotores se reserva el derecho de hacer cambios sin previo aviso con el fin de mejorar nuestros productos 2010

- MODELS**
 CNE55
 CNE65
 CNY50
 CNY60

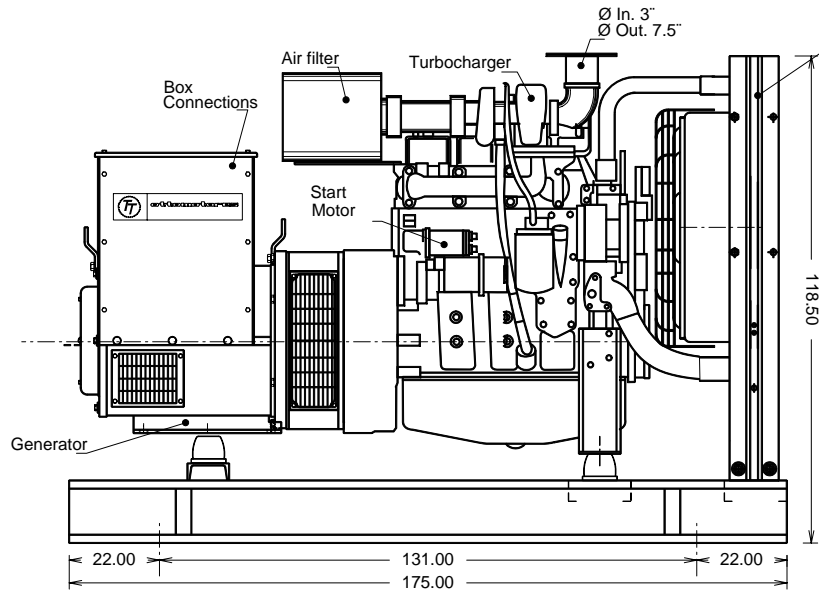

SIDE VIEW

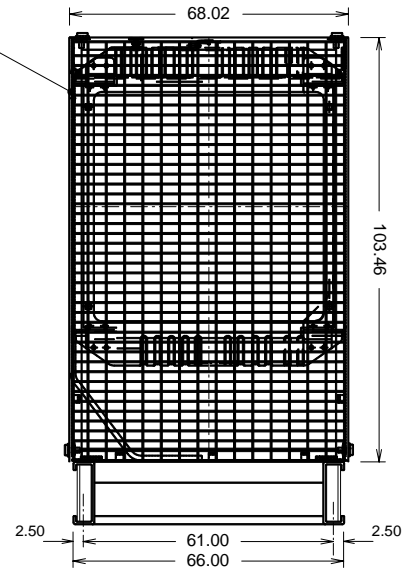

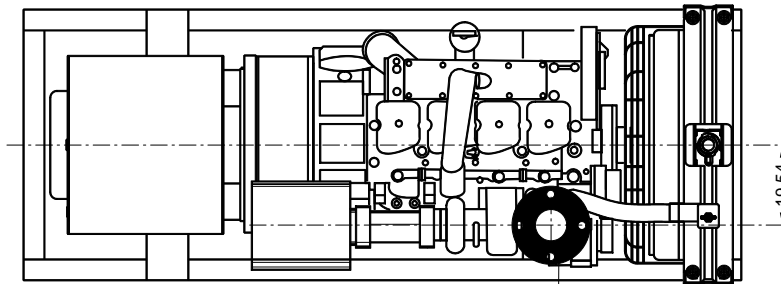

FRONT VIEW



TOP VIEW

DESCRIPTION	
RADIATOR:	OT 5
ENGINE:	4BT 3.9 G3/G4
AIR FILTER:	AH1107
BASE FRAME:	BMT-4B3-STF
SPRING AVMS5	4 PZS

NOTES:
 -THE GENSET DIMENSIONS ARE THE SAME BY FAMILY MODEL, THERE COULD BE ONLY DIFFERENCES ON THE ALTERNATOR LENGTH SEE SPECIFIC GENERAL ARRANGEMENT DRAWING OF CERTAIN MODEL
 -TOTAL WEIGHT COULD VARY CHECK RATING CHART FOR EACH MODEL

Customer:	S/O:	Title: CUMMINS ENGINE 4BT3.9G/G4 - STAMFORD ALTERNATOR			
		Draw: R.G.C.	Revised: F.H.M.	Certificated: F.H.M.	Code: CNE/Y-02
		Date: JAN 05th 2005	Date: JAN 05th 2005	Date: JAN 05th 2005	Dept.: Engineering
		 		Marks: cms	Draw:
				Scale: s/e	Of:
Rev.	Description	Date	Certificated		
Reviews				Otomotors keeps the right to change the information with out prior notice	



Cummins Inc.
Columbus, Indiana 47202-3005
Engine Data Sheet

Basic Engine Model:
4BT3.3-G3

Curve Number:
FR-30233

G-DRIVE
B3.3
1

Engine Critical Parts List:
CPL: N/A

Date:
13May08

Displacement : **3.3 litre (199 in³)**

Bore : **95 mm (3.74 in)** Stroke : **115 mm (4.53 in)**

No. of Cylinders : **4**

Aspiration : **Turbocharged**

Engine Speed rpm	Standby Power		Prime Power		Continuous Power	
	kWm	hp	kWm	hp	kWm	hp
1500	51	68	46	62	N/A	N/A
1800	60	80	54	72	N/A	N/A

Engine Performance Data @ 1500 rpm

OUTPUT POWER			FUEL CONSUMPTION			
%	kWm	hp	kg/ kWm·h	lb/ hp·h	litre/ hour	US gal/ hour
STANDBY POWER						
100	51	68	0.217	0.358	13	3.4
PRIME POWER						
100	46	62	0.212	0.349	11	3.0
75	35	47	N.A.	N.A.	N.A.	N.A.
50	23	31	N.A.	N.A.	N.A.	N.A.
25	12	16	N.A.	N.A.	N.A.	N.A.

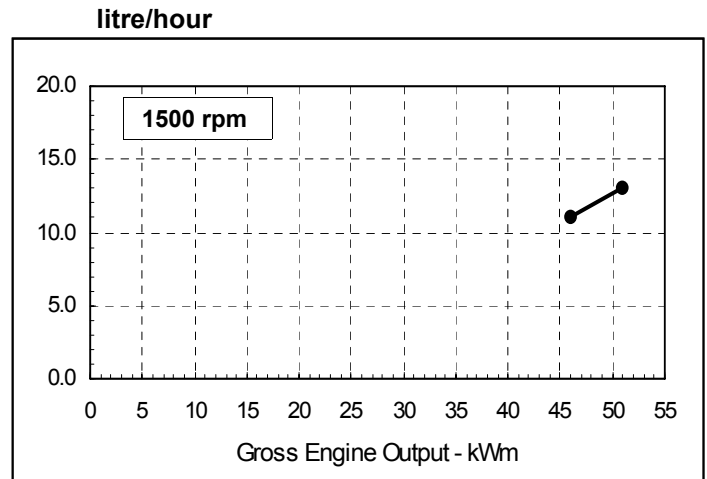

Engine Performance Data @ 1800 rpm

OUTPUT POWER			FUEL CONSUMPTION			
%	kWm	hp	kg/ kWm·h	lb/ hp·h	litre/ hour	US gal/ hour
STANDBY POWER						
100	60	80	0.216	0.355	15	4.0
PRIME POWER						
100	54	72	0.212	0.349	13	3.5
75	41	54	N.A.	N.A.	N.A.	N.A.
50	27	36	N.A.	N.A.	N.A.	N.A.
25	14	18	N.A.	N.A.	N.A.	N.A.

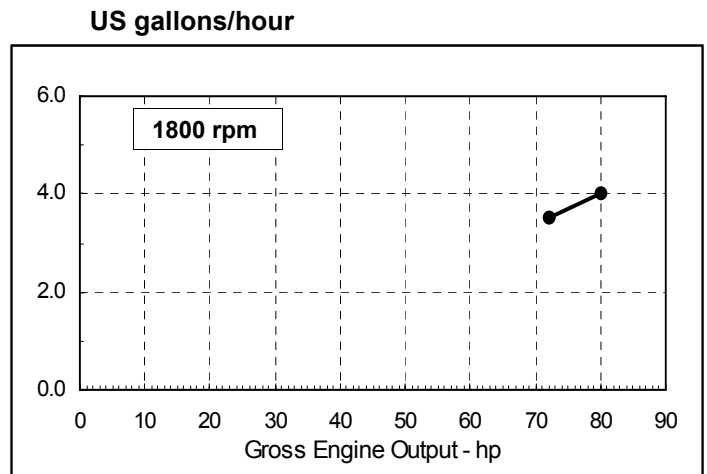

CONVERSIONS:(litres = US Gal x 3.785) (US Gal = litres x 0.2642)

Data Subject to Change Without Notice

These guidelines have been formulated to ensure proper application of generator drive engines in A.C. generator set installations. **STANDBY POWER RATING:** Applicable for supplying emergency power for the duration of the utility power outage. No overload capability is available for this rating. Under no condition is an engine allowed to operate in parallel with the public utility at the Standby Power rating. This rating should be applied where reliable utility power is available. A Standby rated engine should be sized for a maximum of an 80% average load factor and 200 hours of operation per year. This includes less than 25 hours per year at the Standby Power rating. Standby ratings should never be applied except in true emergency power outages. Negotiated power outages contracted with a utility company are not considered an emergency. **PRIME POWER RATING:** Applicable for supplying electric power in lieu of commercially purchased power. Prime Power applications must be in the form of one of the following two categories: **UNLIMITED TIME RUNNING PRIME POWER:** Prime Power is available for an unlimited number of hours per year in a variable load application. Variable load should not exceed a 70% average of the Prime Power rating during any operating period of 250 hours. The total operating time at 100% Prime Power shall not exceed 500 hours per year. A 10% overload capability is available for a period of 1 hour within a 12-hour period of operation. Total operating time at the 10% overload power shall not exceed 25 hours per year. **LIMITED TIME RUNNING PRIME POWER:** Limited Time Prime Power is available for a limited number of hours in a non-variable load application. It is intended for use in situations where power outages are contracted, such as in utility power curtailment. Engines may be operated in parallel to the public utility up to 750 hours per year at power levels never to exceed the Prime Power rating. The customer should be aware, however, that the life of any engine will be reduced by this constant high load operation. Any operation exceeding 750 hours per year at the Prime Power rating should use the Continuous Power rating. **CONTINUOUS POWER RATING:** Applicable for supplying utility power at a constant 100% load for an unlimited number of hours per year. No overload capability is available for this rating.

Reference AEB 10.47 for determining Electrical Output.

Data shown above represent gross engine performance capabilities obtained and corrected in accordance with ISO-3046 conditions of 100 kPa (29.53 in Hg) barometric pressure [110 m (361 ft) altitude], 25 °C (77 °F) air inlet temperature, and relative humidity of 30% with No. 2 diesel or a fuel corresponding to ASTM D2. Derates shown are based on 15 in H₂O air intake restriction and 2 in Hg exhaust back pressure.

The fuel consumption data is based on No. 2 diesel fuel weight at 0.85 kg/litre (7.1 lbs/US gal). Power output curves are based on the engine operating with fuel system, water pump and lubricating oil pump; not included are battery charging alternator, fan, optional equipment and driven components.

Data Status: --Limited Production--

Data Tolerance: ± 5%

Chief Engineer:

Operation At Elevated Temperature And Altitude:

The engine may be operated at:

1800 RPM up to 3280ft. (1000 m) and 104°F (40°C) without power deration.

1500 RPM up to 3280ft. (1000 m) and 104°F (40°C) without power deration.

For sustained operation above these conditions, derate by TBD% per 328ft. (100 m), and TBD% per 18°F (TBD% per 10°C).

Cummins Inc.

Engine Data Sheet

ENGINE MODEL: **4BT3.3-G3**

CONFIGURATION NUMBER : D782002GX03

DATA SHEET : DS-30233

DATE : 13May08

PERFORMANCE CURVE : FR-302033

INSTALLATION DIAGRAM

• Fan to Flywheel: 4953779

CPL NUMBER

• Engine Critical Parts List: N/A

GENERAL ENGINE DATA

Type	4-Cycle; In-line; 4-Cylinder Diesel
Aspiration	Turbocharged
Bore x Stroke	3.74 x 4.53 (95 x 115)
Displacement	199 (3.3)
Compression Ratio	18 : 1

Dry Weight (Approximate), Fan to Flywheel Engine	— lb (kg)	584	(265)
Wet Weight (Approximate), Fan to Flywheel Engine	— lb (kg)	599	(272)

Moment of Inertia of Rotating Components • with FW 30001 Flywheel	— lb _m • ft ² (kg • m ²)	29.8	(1.25)
Center of Gravity from Rear Face of Block	— in (mm)	10.07	(256)
Center of Gravity Above Crankshaft Centerline	— in (mm)	4.33	(110)
Maximum Static Loading at Rear Main Bearing	— lb (kg)	275	(125)

ENGINE MOUNTING

Maximum Bending Moment at Rear Face of Block	— lb • ft (N • m)	918	(1245)
--	-------------------	-----	--------

EXHAUST SYSTEM

Maximum Back Pressure	— in Hg (kPa)	3	(75)
-----------------------------	---------------	---	------

AIR INDUCTION SYSTEM

Maximum Intake Air Restriction • with Dirty Filter Element	— in H ₂ O (kPa)	30	(102)
• with Clean Filter Element	— in H ₂ O (kPa)	12	(41)

COOLING SYSTEM**Jacket Water Circuit Requirements**

Coolant Capacity — Engine Only	— US gal (litre)	1.2	(4.5)
Maximum Static Head of Coolant Above Engine Crank Centerline	— ft (m)	26	(8)
Standard Thermostat (Modulating) Range	— °F (°C)	180-203	(82-95)
Minimum Pressure Cap	— psi (kPa)	7	(50)
Maximum Top Tank Temperature for Standby / Prime Power	— °F (°C)	221/212	(105/100)
Maximum Coolant Friction Head External to Engine	— psi (kPa)	4/5	(28/35)

LUBRICATION SYSTEM

Oil Pressure @ Idle Speed	— psi (kPa)	34	(235)
@ Governed Speed	— psi (kPa)	67	(461)
Maximum Oil Temperature	— °F (°C)	248	(120)
Oil Capacity with OP 30002 Oil Pan : Low - High	— US gal (litre)	1.45-1.9	(5.5-7.0)
Total System Capacity (Including Filter)	— US gal (litre)	2.1	(8.0)

FUEL SYSTEM

Type Injection System.....	Zexel A Direct Injection	
Maximum Inlet Restriction at Injection Pump..... — in Hg (mm Hg)	2.9	(73)
Maximum Allowable Head on Injector Return Line (Consisting of Friction Head and Static Head)..... — in Hg (mm Hg)	15	(381)
Maximum Fuel Flow to Injection Pump..... — US gph (litre/hr)	4.5	(17.2)
Fuel Flow to Lift Pump @ 43 psi (3 kg/cm ²)..... — US gph (litre/hr)	10.5	(40)

ELECTRICAL SYSTEM

Cranking Motor (Heavy Duty, Positive Engagement)..... — volt	12
Battery Charging System, Negative Ground..... — ampere	35
Maximum Allowable Resistance of Cranking Circuit..... — ohm	0.00075
Minimum Recommended Battery Capacity	
• Cold Soak @ 0 °F to 32 °F (-18 °C to 0 °C)..... — 0°F CCA	725

COLD START CAPABILITY

Minimum Ambient Temperature for NFPA 110 Cold Start (90 degree °F Coolant Temperature)..... — °F (°C)	-9	(-23)
Minimum Ambient Temperature for Unaided Cold Start..... — °F (°C)	12.2	(-11)

PERFORMANCE DATA

- All data is based on:
- Engine operating with fuel system, water pump, lubricating oil pump, air cleaner and exhaust silencer; not included are battery charging alternator, fan, and optional driven components.
 - Engine operating with fuel corresponding to grade No. 2-D per ASTM D975.
 - ISO 3046, Part 1, Standard Reference Conditions of:

Barometric Pressure : 100 kPa (29.53 in Hg)	Air Temperature : 25 °C (77 °F)
Altitude : 110 m (361 ft)	Relative Humidity : 30%

Steady State Stability Band at Any Constant Load..... — %	+/-	0.25
Estimated Free Field Sound Pressure Level of a Typical Generator Set;		
Excludes Exhaust Noise; at Rated Load and 7.5 m (24.6 ft); @1800 rpm..... — dBA		N.A.
Exhaust Noise at 1 m Horizontal from Centerline of Exhaust Pipe Outlet Upwards at 45 °..... — dBA		N.A.

Governed Engine Speed..... — rpm	
Engine Idle Speed..... — rpm	
Gross Engine Power Output..... — hp (kW)	
Brake Mean Effective Pressure..... — psi (kPa)	
Piston Speed..... — ft/min (m/s)	
Friction Horsepower..... — HP (kW)	
Engine Water Flow at Stated Friction Head External to Engine:	
• 1 psi Friction Head..... — US gpm (litre/s)	
• Maximum Friction Head..... — US gpm (litre/s)	

	STANDBY POWER		PRIME POWER	
	60 Hz	50 Hz	60 Hz	50 Hz
	1800	1500	1800	1500
	700 - 900	700 - 900	700 - 900	700 - 900
Gross Engine Power Output..... — hp (kW)	80 (60)	68 (51)	72 (54)	62 (46)
Brake Mean Effective Pressure..... — psi (kPa)	177 (1220)	180 (1241)	159 (1096)	165 (1137)
Piston Speed..... — ft/min (m/s)	1359 (6.9)	1133 (5.8)	1359 (6.9)	1133 (5.8)
Friction Horsepower..... — HP (kW)	8.8 (6.6)	6.0 (4.5)	8.8 (6.6)	6.0 (4.5)
Engine Water Flow at Stated Friction Head External to Engine:				
• 1 psi Friction Head..... — US gpm (litre/s)	22 (1.4)	19 (1.2)	22 (1.4)	19 (1.2)
• Maximum Friction Head..... — US gpm (litre/s)	14 (0.9)	12 (0.8)	14 (0.9)	12 (0.8)
Intake Air Flow..... — cfm (litre/s)	139 (65)	107 (51)	131 (62)	102 (48)
Exhaust Gas Temperature..... — °F (°C)	1090 (588)	1111 (599)	1014 (546)	1034 (557)
Exhaust Gas Flow..... — cfm (litre/s)	420 (198)	330 (156.)	375 (177)	298 (141)
Air to Fuel Ratio..... — air : fuel	20 : 1	19 : 1	22 : 1	21 : 1
Radiated Heat to Ambient..... — BTU/min (kW)	841 (14.8)	851 (15)	733 (12.9)	684 (12.0)
Heat Rejection to Coolant..... — BTU/min (kW)	2181 (38.3)	1717 (30.2)	1858 (32.7)	1534 (27.0)
Heat Rejection to Exhaust..... — BTU/min (kW)	2858 (50.3)	2270 (39.9)	2472 (43.5)	1983 (34.9)

N.A. - Not Available
N/A - Not Applicable to this Engine
TBD - To Be Determined

ENGINE MODEL : 4BT3.3-G3
DATA SHEET : DS-30233
DATE : 13May08
CURVE NO. : FR-30233

FRAME UC224D

WINDING 311

RATINGS	REFER TO RATINGS BOOK
OVERLOAD	REFER TO RATINGS BOOK
ALTITUDE	REFER TO RATINGS BOOK
AMBIENT TEMP.	REFER TO RATINGS BOOK

CONTROL SYSTEM SER. 3	SEPARATELY EXCITED BY P.M.G.		
A.V.R.	MX341	MX321	
VOLTAGE REGULATION	± 1.0 %	± 0.5%	WITH 4% ENGINE GOVERNING
SUSTAINED SHORT CIRCUIT	REFER TO SHORT CIRCUIT DECREMENT CURVES OF THIS SECTION		

CONTROL SYSTEM SER. 4	SELF EXCITED		
A.V.R.	SX460	SX440	SX421
VOLTAGE REGULATION	± 1.5%	± 1.0%	± 0.5%
SUSTAINED SHORT CIRCUIT	SERIES 4 CONTROL DOES NOT SUSTAIN A SHORT CIRCUIT CURRENT		

INSULATION SYSTEM	CLASS H	
PROTECTION	IP22 STANDARD - IP23 OPTIONAL (5% DERATE)	
RATED POWER FACTOR	0.8	
STATOR WINDING	DOUBLE LAYER CONCENTRIC	
WINDING PITCH	TWO THIRDS	
WINDING LEADS	12	
STATOR WDG. RESISTANCE	0.129 Ohms PER PHASE AT 22°C SERIES STAR CONNECTED	
ROTOR WDG. RESISTANCE	0.64 Ohms at 22°C	
R.F.I. SUPPRESSION	B.S. 800 VDE 0875G VDE 0875N For other standards apply to the factory	
WAVEFORM DISTORTION	NO LOAD < 1.8% NON-DISTORTING BALANCED LINEAR LOAD < 5.0%	
MAXIMUM OVERSPEED	2250 Rev/Min	
BEARING DRIVE END	BALL. 6312 - 2RS. (ISO)	
BEARING NON-DRIVE END	BALL. 6309 - 2RS. (ISO)	
EFFICIENCY	REFER TO EFFICIENCY CURVES OF THIS SECTION	
	1 BEARING	2 BEARING
WEIGHT COMP. GENERATOR	287 kg	291 kg
WEIGHT WOUND STATOR	86 kg	86 kg
WEIGHT WOUND ROTOR	89.68 kg	78.38 kg
WR ² INERTIA	0.4742 kgm ²	0.4303 kgm ²

	50 Hz				60 Hz			
TELEPHONE INTERFERENCE	THF<2%				TIF<50			
COOLING AIR	0.216 m ³ /sec 458 cfm				0.281 m ³ /sec 595 cfm			
VOLTAGE SERIES STAR (Y)	380	400	415	440	416	440	460	480
VOLTAGE PARALLEL STAR (Y)	190	200	208	220	208	220	230	240
VOLTAGE EDISON DELTA (Δ)	220	230	240	250	240	254	266	277
KVA BASE RATING FOR REACTANCE VALUES	50.0	50.0	50.0	48.0	60.0	62.5	62.5	65.0
X _d DIR. AXIS SYNCHRONOUS	2.33	2.11	1.95	1.66	3.04	2.82	2.59	2.46
X' _d DIR. AXIS TRANSIENT	0.18	0.16	0.15	0.12	0.22	0.20	0.18	0.17
X'' _d DIR. AXIS SUBTRANSIENT	0.12	0.11	0.10	0.09	0.15	0.13	0.12	0.11
X _q QUAD. AXIS REACTANCE	1.07	0.97	0.90	0.76	1.40	1.30	1.19	1.13
X'' _q QUAD. AXIS SUBTRANSIENT	0.14	0.13	0.12	0.11	0.14	0.12	0.11	0.11
X _L LEAKAGE REACTANCE	0.08	0.07	0.06	0.06	0.09	0.09	0.08	0.08
X ₂ NEGATIVE SEQUENCE	0.13	0.12	0.11	0.10	0.14	0.12	0.11	0.11
X ₀ ZERO SEQUENCE	0.09	0.08	0.07	0.07	0.09	0.09	0.08	0.08
REACTANCES ARE SATURATED				VALUES ARE PER UNIT AT RATING AND VOLTAGE INDICATED				
T' _d TRANSIENT TIME CONST.	0.027 sec							
T'' _d SUB-TRANSTIME CONST.	0.006 sec							
T' _{do} O.C. FIELD TIME CONST.	0.70 sec							
T _a ARMATURE TIME CONST.	0.0055 sec							
SHORT CIRCUIT RATIO	1/xd							

**SERIES 3 WINDING 311
LOCKED ROTOR MOTOR STARTING CURVE**

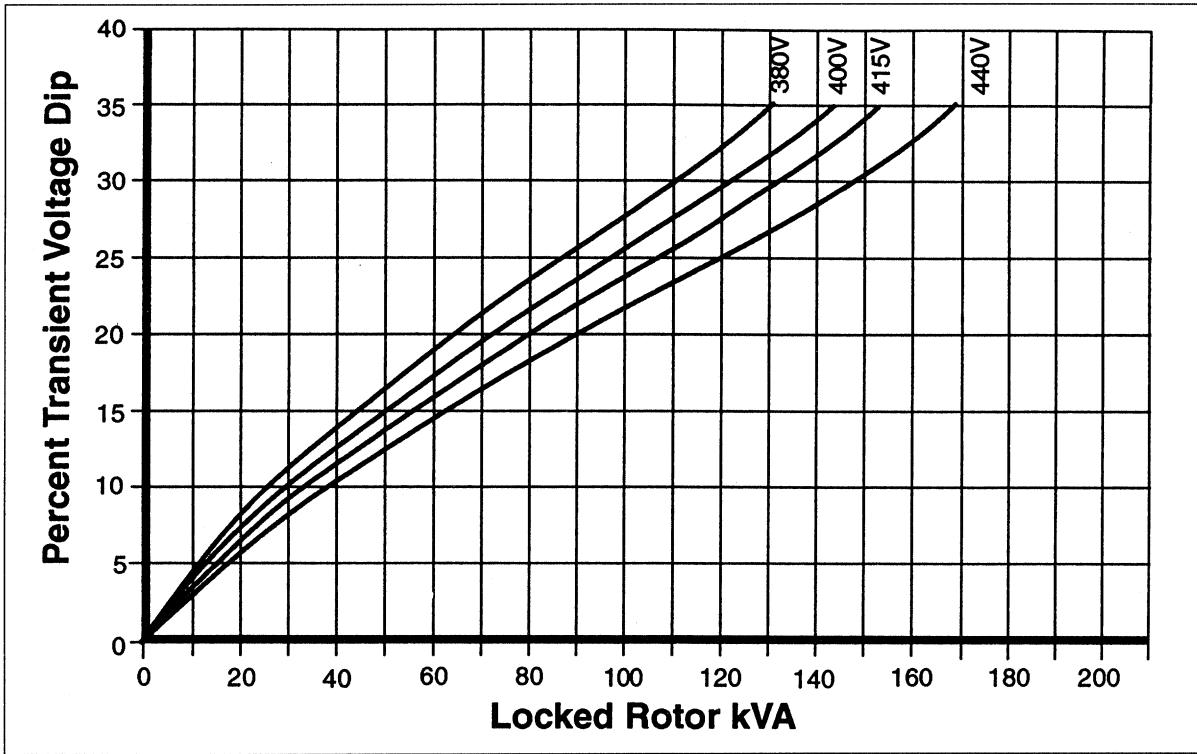

FRAME UC224D 60 HZ

**SERIES 3 WINDING 311
LOCKED ROTOR MOTOR STARTING CURVE**

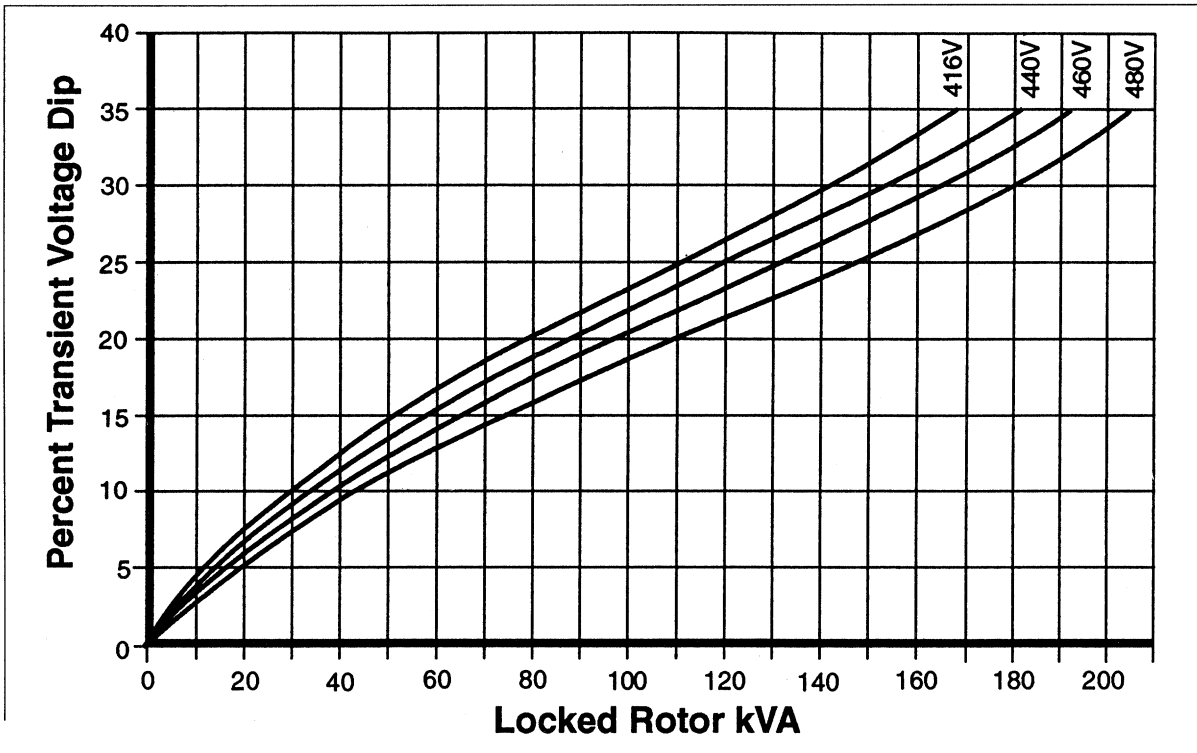

**SERIES 4 WINDING 311
LOCKED ROTOR MOTOR STARTING CURVE**

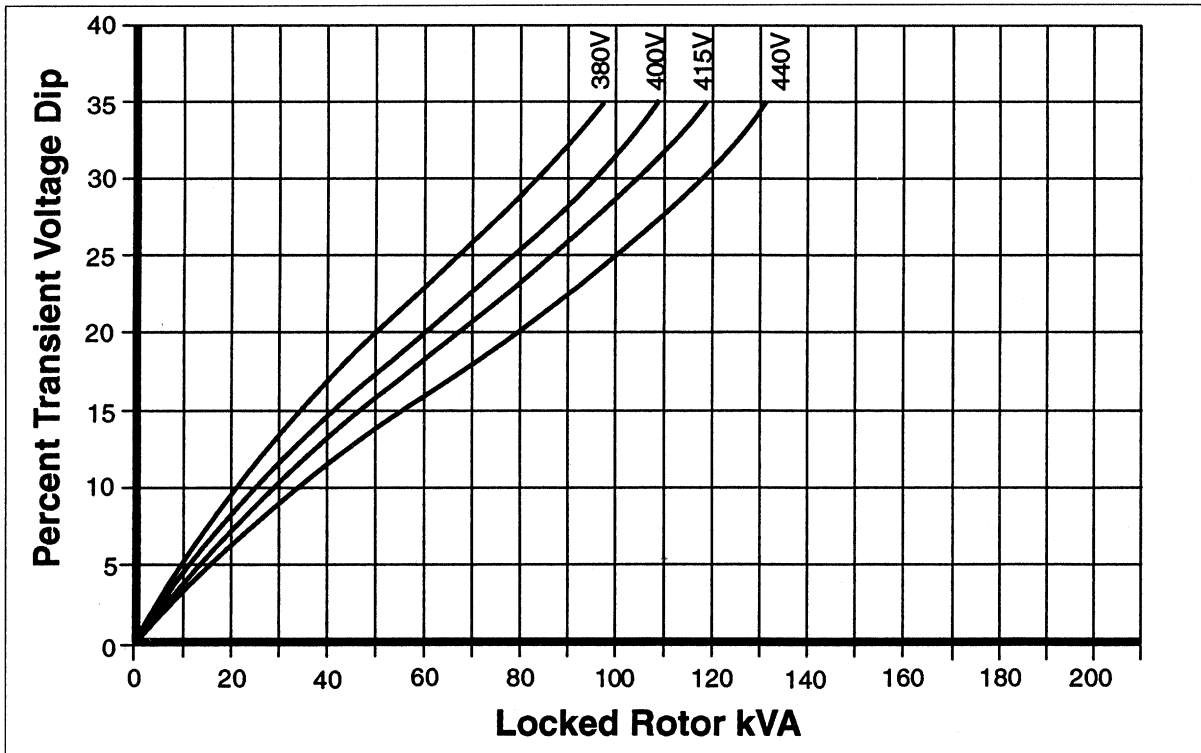

FRAME UC224D 60 HZ

**SERIES 4 WINDING 311
LOCKED ROTOR MOTOR STARTING CURVE**

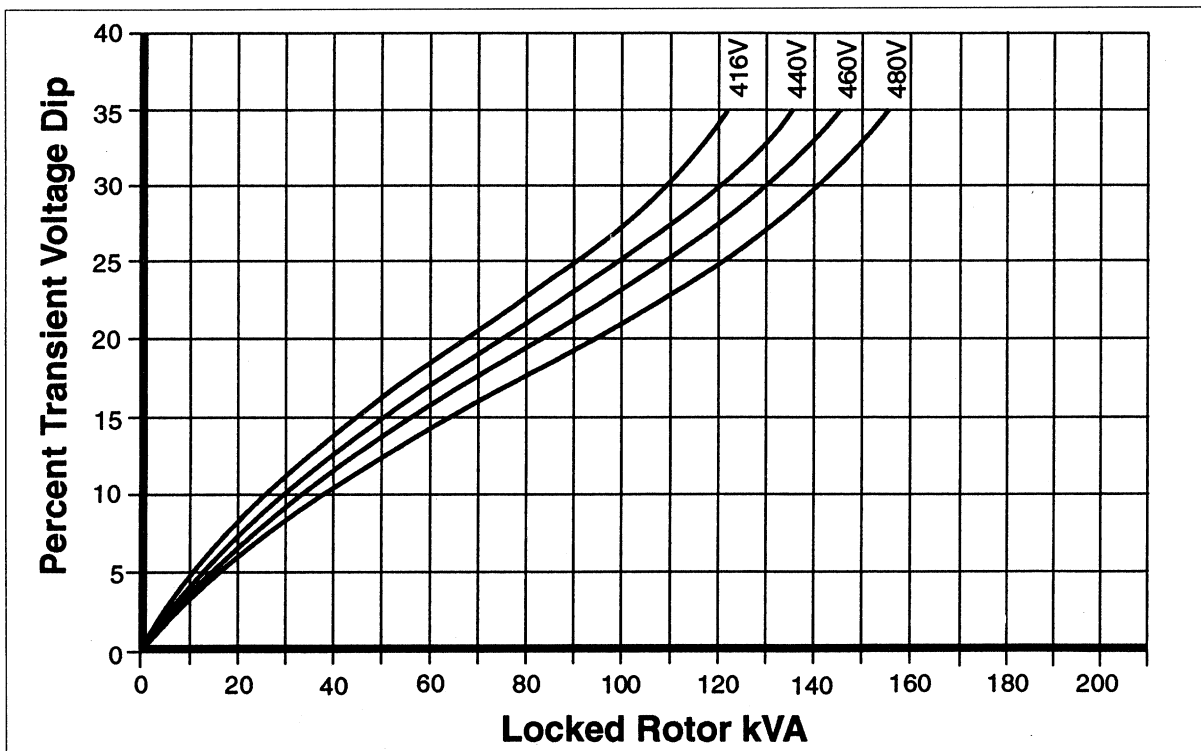

THREE PHASE EFFICIENCY CURVES

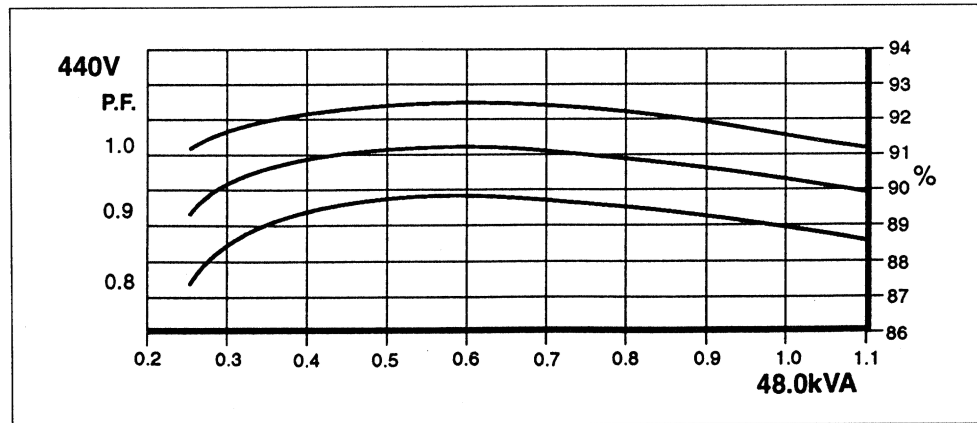
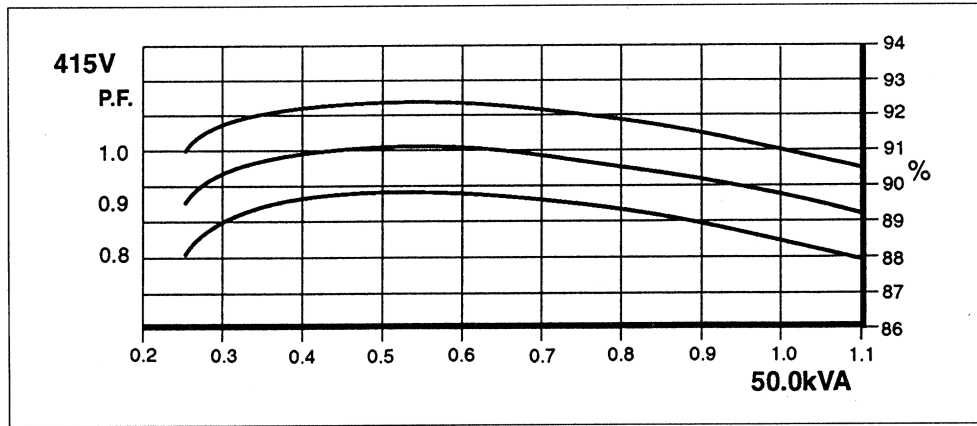
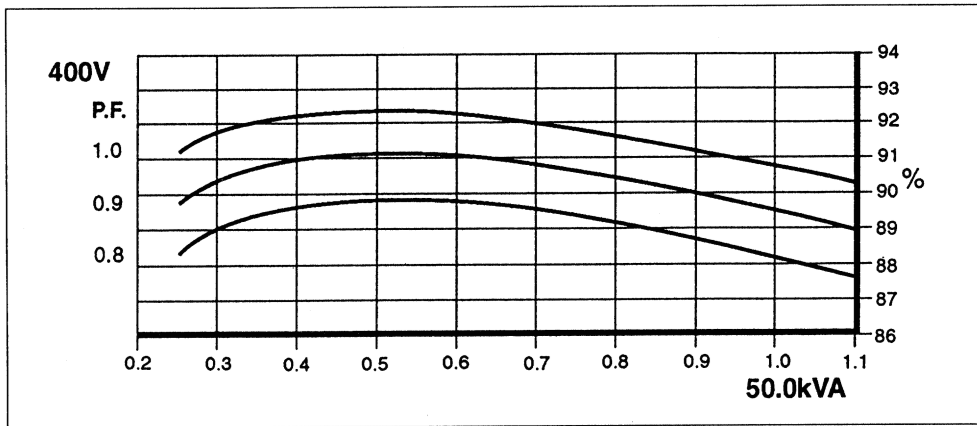
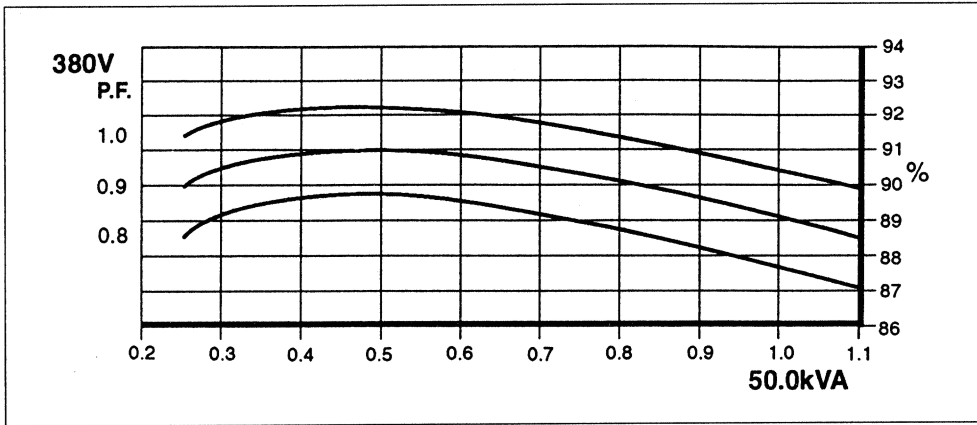

THREE PHASE EFFICIENCY CURVES

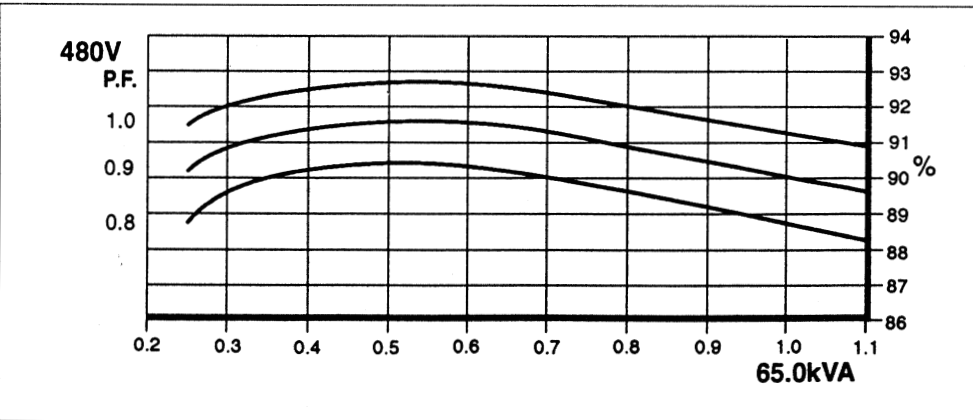
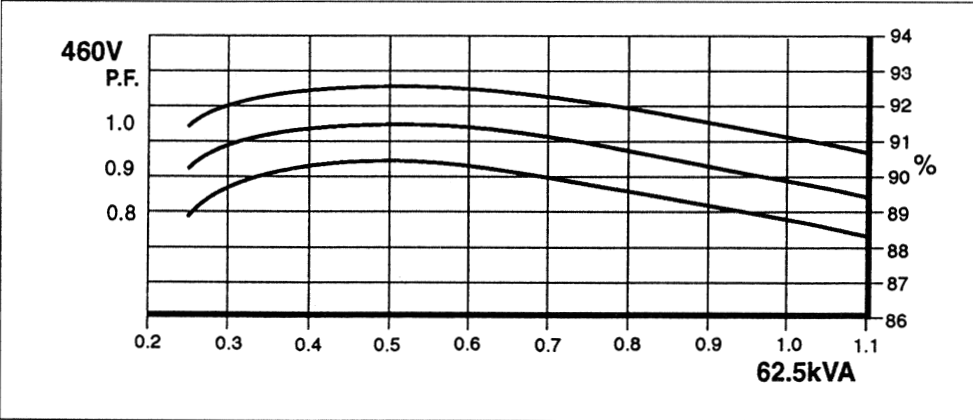
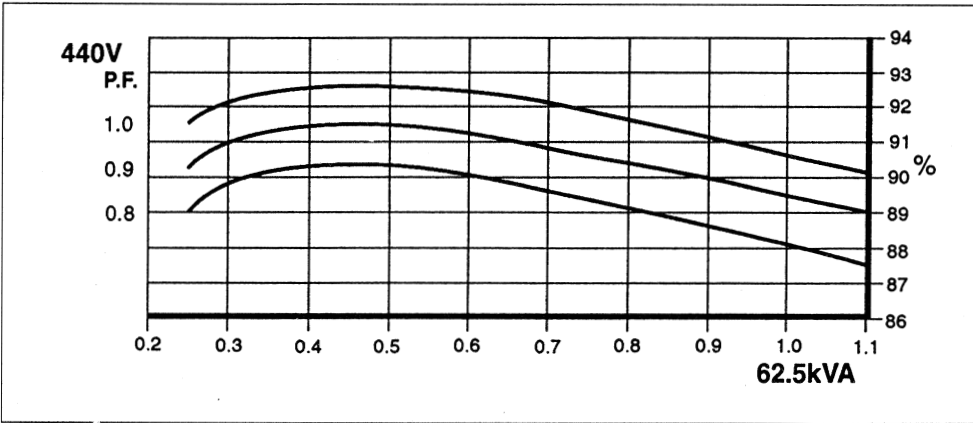
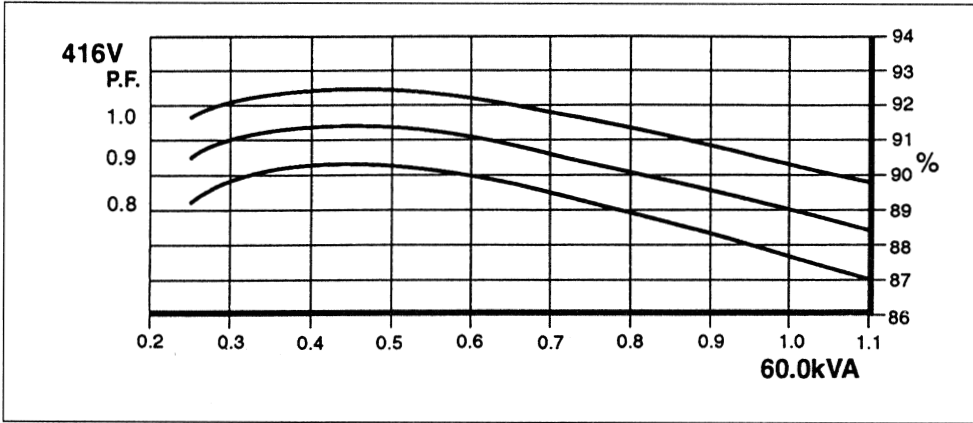

FRAME UC224D 50 HZ

SERIES THREE

Three Phase Short Circuit Decrement Curve No-load Excitation at Rated Speed

Based on series star (wye) connection

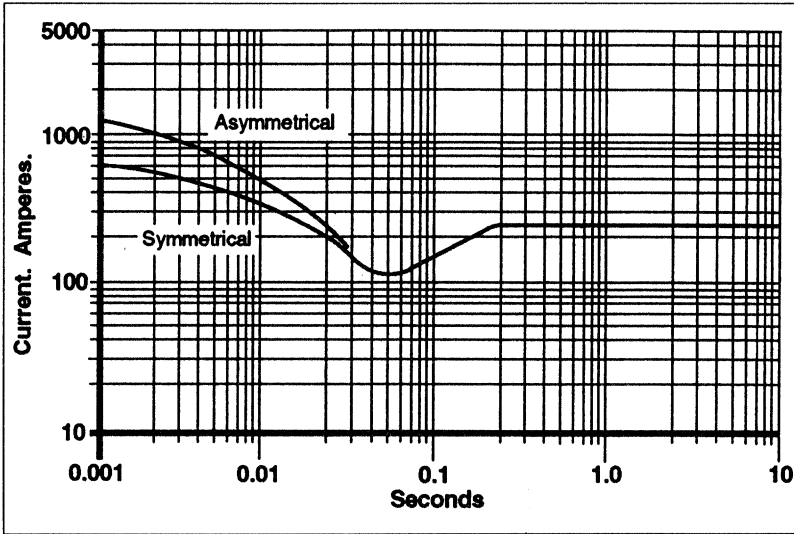

Note 1

The following multiplication factors should be used to adjust the values from curve between time 0.001 seconds and the minimum current point in respect of nominal operating voltage :

VOLTAGE	FACTOR
380 V	X 1.0
400 V	X 1.07
415 V	X 1.12
440 V	X 1.18

The sustained current value is constant irrespective of voltage level.

Note 2

The following multiplication factors should be used to convert the values calculated in accordance with NOTE 1 to those applicable to the various types of short circuit :

	3 PHASE	2 PHASE L-L	1 PHASE L-N
Instantaneous	X 1.00	X 0.87	X 1.30
Minimum	X 1.00	X 1.80	X 3.20
Sustained	X 1.00	X 1.50	X 2.50
Max. sustained duration	10 sec.	5 sec.	2 sec.

All other times are unchanged.

Note 3

Curves are drawn for Series Star (Wye) connected machines. For other connections the following multipliers should be applied to current values shown :

Parallel Star (Wye) Curve current value X 2
Series Delta (Δ) Curve current value X 1.732

Times are unchanged.

FRAME UC224D 60 HZ

SERIES THREE

Three Phase Short Circuit Decrement Curve No-load Excitation at Rated Speed

Based on series star (wye) connection

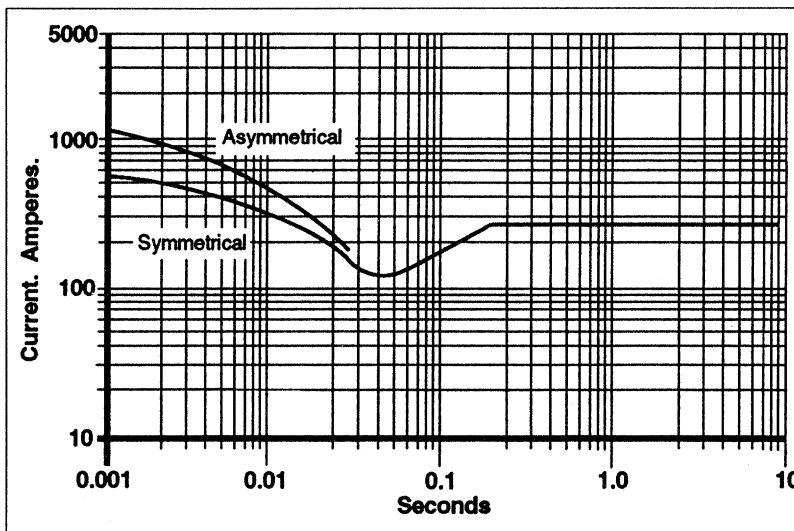

Note 1

The following multiplication factors should be used to adjust the values from curve between time 0.001 seconds and the minimum current point in respect of nominal operating voltage :

VOLTAGE	FACTOR
416 V	X 1.0
440 V	X 1.06
460 V	X 1.12
480 V	X 1.17

The sustained current value is constant irrespective of voltage level.

Note 2

The following multiplication factors should be used to convert the values calculated in accordance with NOTE 1 to those applicable to the various types of short circuit :

	3 PHASE	2 PHASE L-L	1 PHASE L-N
Instantaneous	X 1.00	X 0.87	X 1.30
Minimum	X 1.00	X 1.80	X 3.20
Sustained	X 1.00	X 1.50	X 2.50
Max. sustained duration	10 sec.	5 sec.	2 sec.

All other times are unchanged.

Note 3

Curves are drawn for Series Star (Wye) connected machines. For other connections the following multipliers should be applied to current values shown :

Parallel Star (Wye) Curve current value X 2
Series Delta (Δ) Curve current value X 1.732

Times are unchanged.

NEWAGE
INTERNATIONAL

NEWAGE INTERNATIONAL LIMITED

PO BOX 17, Barnack Road, Stamford, Lincolnshire PE9 2NB, England.

Telephone 44 (0) 1780 484000

Telex 32268 Cables Newage Stamford Fax 44 (0) 1780 484100